

CERÁMICA **SAN PEDRO**



• CATÁLOGO DE PRODUCTOS •



PRODUCTOS

01. Azulejos Artesanales

Colores

Medidas y Precios

02. Fachaletas y Tabiques

Colores

Medidas y Precios

03. Azulejos Cerámicos

Biselados

Lisos

01 AZULEJOS ARTESANALES



Proyecto: Hotel Humano - Grupo Habita en Puerto Escondido, Oaxaca.

COLORES



Blanco Aqua



Blanco Hueso



Beige



Salmón



Terra Transparente



Café Nácar



Rojo Caramelo



Café Caramelo



Café Chocolate



Tinto



Ciruela



Lila



Rosa Palo



Rosa Cuarzo



Coral

**Los colores mostrados en las fotografías son indicativos, pueden variar del color de la pieza real. Sugerimos validar la pieza antes de comprar.*



Verde Menta



Verde Aqua



Verde Esther



Verde Pálido



Verde Olivo



Verde Militar



Verde Esmeralda

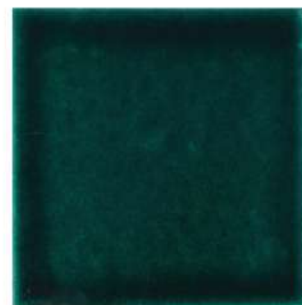

Verde Pavorreal



Verde Botella



**Los colores mostrados en las fotografías son indicativos, pueden variar del color de la pieza real. Sugerimos validar la pieza antes de comprar.*

Proyecto: Niddo Café
Arquitectos: Frida Escobedo y Arq. Mauricio Mesta



Proyecto de: Rosela Barraza, CANA - Ciudad de México



Turquesa Pálido

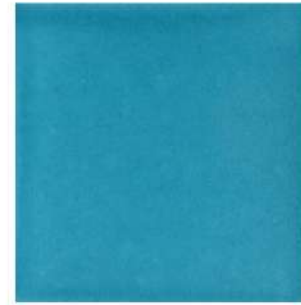

Turquesa



Bluegrass



Azul Cielo



Azul Aqua



Azul Acero



Azul Marino



Azul Cobalto



Azul Prusia

**Los colores mostrados en las fotografías son indicativos, pueden variar del color de la pieza real. Sugerimos validar la pieza antes de comprar.*

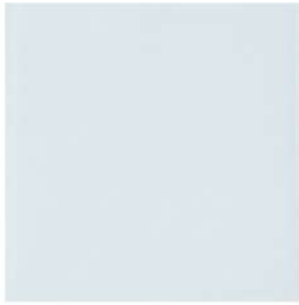

Gris Perla



Gris Aqua



Gris Rata



Negro Grafito



Negro

¿Qué nos
hace
diferentes?

01



Tenemos más de **40 años de experiencia** en la fabricación de azulejos artesanales.

02



Podemos desarrollar **colores y medidas** para **proyectos especiales**.

03



Apoyamos a los clientes con el **servicio de logística** de principio a fin.



Proyecto: Hotel Boca de Agua - Bacalar

TIPOS DE AZULEJO

LÍNEA TALAVERA



Vista más artesanal
Bisel irregular
Los colores crackelan
Más económico

MEDIDAS



MEDIDA	PZ/M2
5 x 5 cm	400 pz
10x10 cm	100 pz
15x15 cm	44 pz

LÍNEA SUPREMA



Prensado a máquina
Permite una menor junta
Menor crackelado en colores
Medidas rectangulares

MEDIDAS

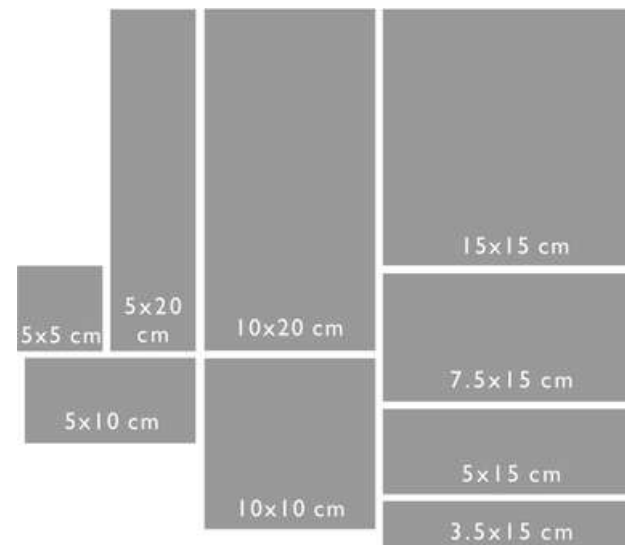

MEDIDA	PZ/M2
10x10 cm	100 pz
15x15 cm	44 pz
5x20 cm	100 pz
10x20 cm	50 pz
5x10 cm	200 pz
3x15 cm	220 pz
5x15 cm	132 pz
7x15 cm	88 pz
2.5x10 cm	400 pz
Escama	120 pz
Hexagono	110 pz

02 FACHALETAS Y TABIQUES



Proyecto: Espacio Claro

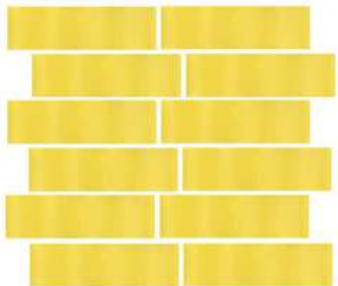

Amarillo Canario

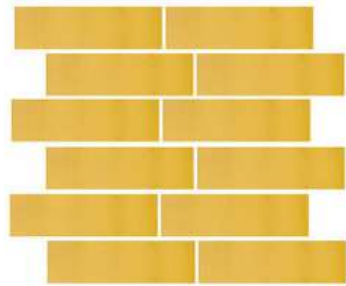

Amarillo Mostaza

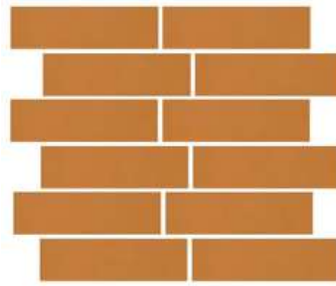

Naranja

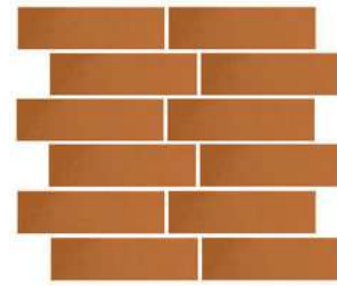

Barro Transparente

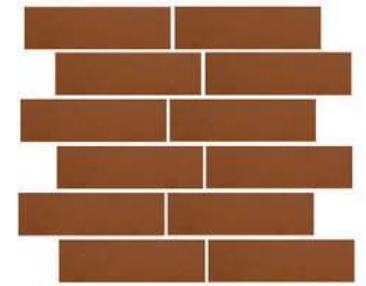

Café Nácar

COLORES



Blanco Aqua

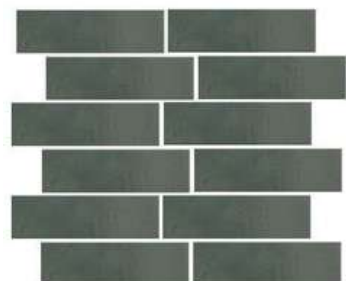

Gris Aqua

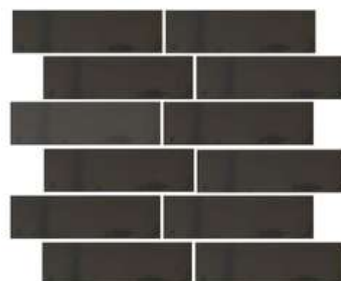

Negro Grafito



Negro

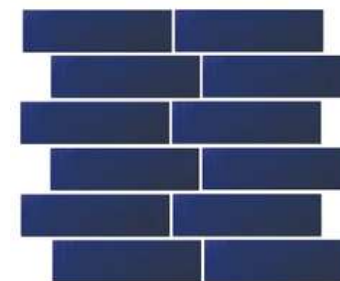

Azul Cobalto



Verde Esmeralda



Verde Aceituna

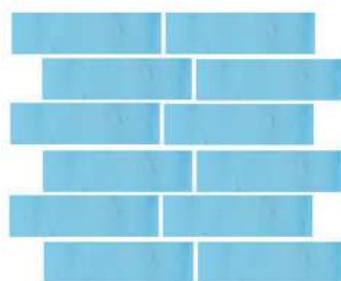

Azul Cielo

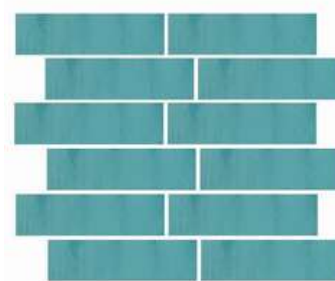

Azul Aquamarina

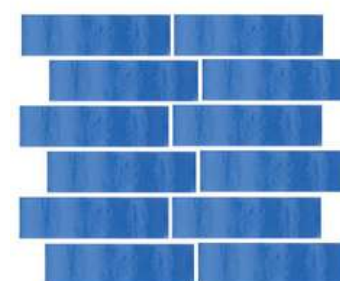

Azul medio

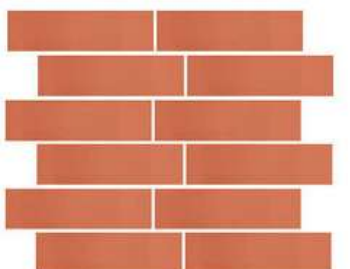

Rosa Coral

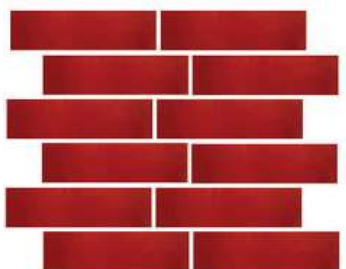

Rojo Sangre

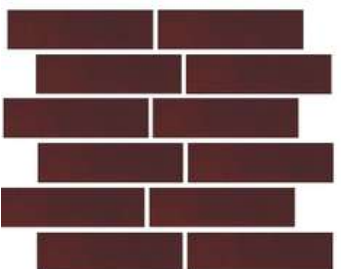

Tinto



Morado

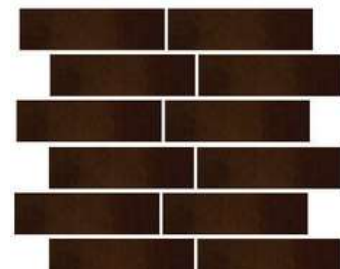

Café Caramelo

**Los colores mostrados en las fotografías son indicativos, pueden variar del color de la pieza real. Sugerimos validar la pieza antes de comprar.*

MEDIDAS Y PRECIOS



Proyecto: Taller Dinamita & Arq. Gabriela Chávez

FACHALETA

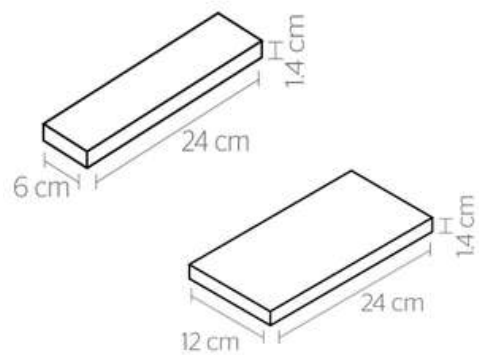

TABIQUE

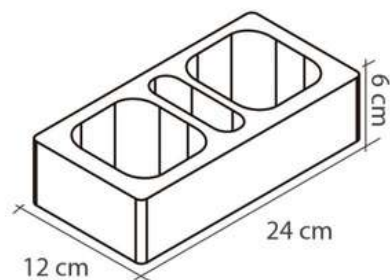

PRODUCTO	MEDIDA	PZ/M2
Fachaleta	6x24 x1.4 cm	60 pz
Fachaleta	12x24x1.4 cm	30 pz
Tabique - 1C	12x24x6 cm	60 pz
Tabique - 2C	12x24x6 cm	60 pz

03 AZULEJOS CERÁMICOS



AZULEJOS BISELADOS

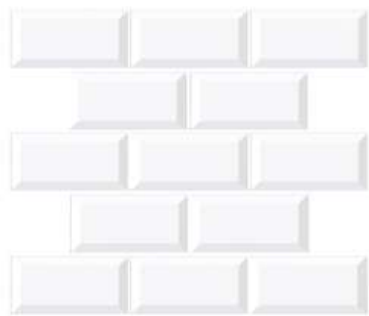
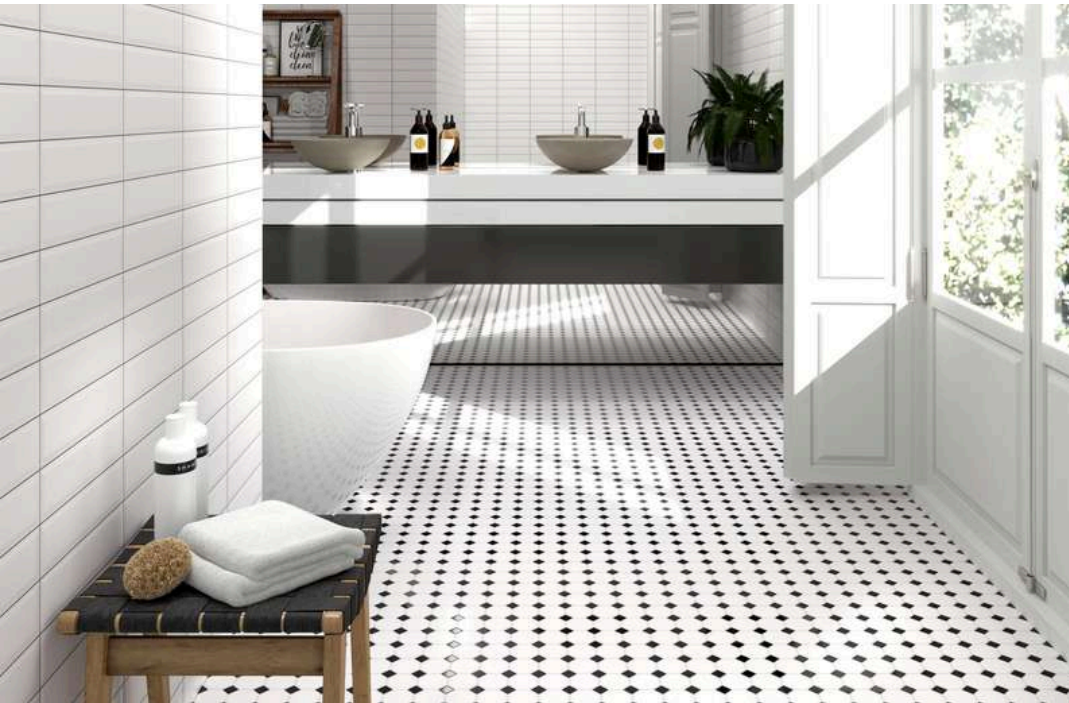

Blanco Brillante
7.5 x 15 cm
M2 x Caja = 1.012

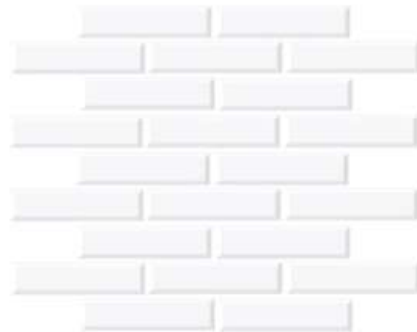

Blanco Brillante
7.5 x 30 cm
M2 x Caja = 1.305

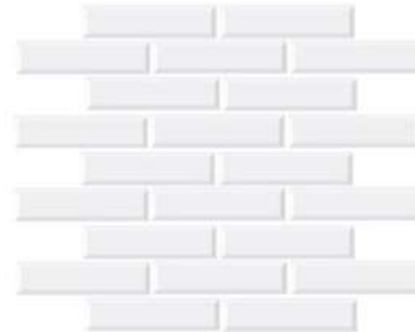

Blanco Mate
7.5 x 30 cm
M2 x Caja = 1.305

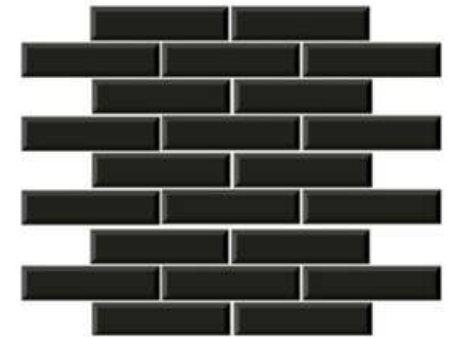

Negro Brillante
7.5 x 30 cm
M2 x Caja = 1.305

AZULEJOS LISOS



Blanco Brillante
7.5 x 30 cm



Blanco Mate
7.5 x 30 cm



Aquamarina*
7.5 x 30 cm

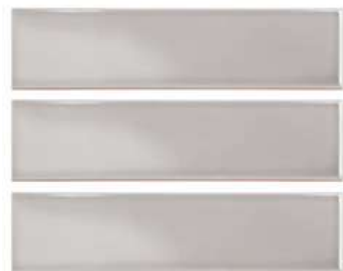

Gris Claro Brillante
7.5 x 30 cm



Gris Oscuro Brillante
7.5 x 30 cm

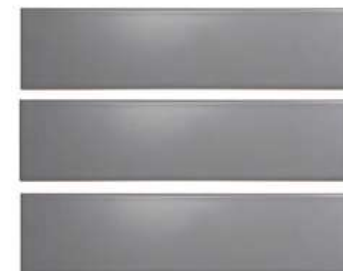

Gris Oscuro Mate
7.5 x 30 cm



Negro Brillante
7.5 x 30 cm

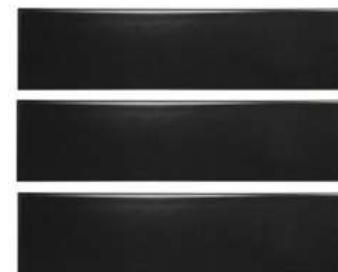

Negro Mate
7.5 x 30 cm

CONTACTO

WHATSAPP

+52 (33) 3577 6958

DIRECCIÓN

Lázaro Cardenas #3485
Guadalajara, Jal. CP 45000

EMAIL

info@sanpedrotile.com.mx

SITIO WEB

www.sanpedrotile.com.mx